

CLASSIC CAR RADIO

BREMEN SQR 46 DAB

BLAUPUNKT

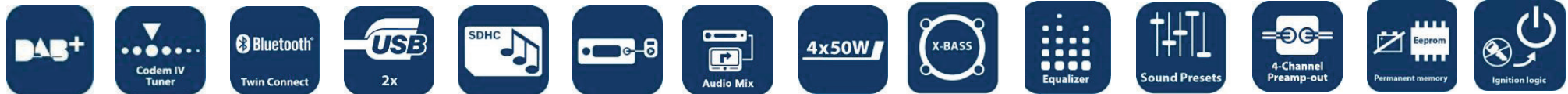

Sales Start
August 2019

**Order Number /
EAN-Code**

2 001 018 000 000
4 260 499 851 347

Highlights

• Radio

- High-End CODEM IV High-End World-Tuner
- FM (RDS), AM Tuner
- DAB+ Tuner built-in

• Data Carrier

- USB, SD, SDHC (up to 32 GB)

• Media player

- Audio from USB/SDHC
- Audio formats MP3, WMA

• Input / Output

- 1x front USB
- 1x rear USB
- 1x front Aux-In
- 1x front SDHC slot
- Steering wheel control input (programmable)

• Equalizer / Amplifier

- 3-band, semi-parametric equalizer
- Sound presets (Rock, Pop, Classic)
- X-Bass
- 4-channel preamp-out (4V)
- Separate Sub-Out
- 4 x 50 Watt max. power

• Bluetooth

- Bluetooth module built-in (HFP, PBAP, A2DP, SPP, AVRCP)
- Twin-Connect
- Phone book access
- Built-in + external microphone
- Navigation audio mix

• General

- Vario Colour (RGB for display & button illumination)
- Fix front panel
- Permanent memory
- Short mounting depth
- DAB+ on-glass antenna included in delivery
- External BT-microphone included in delivery

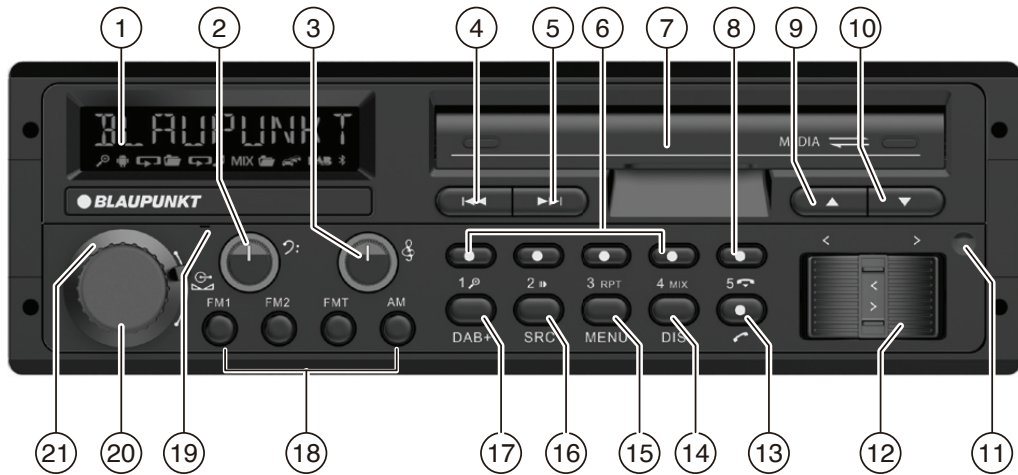

- 1 Display
- 2 Bass Control (Push slightly to move in/ out)
Change the Bass level
- 3 Treble Control (Push slightly to move in/ out)
Change the Treble level
- 4 [◀◀] Button
- 5 [▶▶] Button
Radio mode: Manually step up/ down.
DAB: Manually channel up/ down
Long press: Auto search next ensemble/ used channel
USB/SD: Change previous/ next track
Long press: Fast Forward/ Review
- 6 Keys **1 - 5**
Store/ Recall presets (FM/ AM/ DAB)
- 7 USB/SD/AUX Cover
- 8 [📞] button
Ending/ rejecting a phone call
- 9 [▲] Button
- 10 [▼] Button

- Radio mode: Preset up/ down. Long press: PTY search
DAB: Change to previous/ next known ensemble
Long press: PTY search
USB/SD: Change previous/next folder
- 11 </> button
Radio mode: Auto search previous/ next station
DAB mode: change previous/ next station
USB/SD: Change previous/ next track
Long press: Fast forward/ Review
 - 12 [📞] button
Calling/ answering phone call
 - 13 **DIS** button
Short press: Switch display mode
Long press: Change illumination brightness
 - 14 **MENU** button
Short press: Open settings
Long press: Start INTRO scan (FM/ DAB/ USB/ SD)
 - 15 **SRC** button
Select memory bank or audio source
 - 16 **DAB+** button
Access to DAB mode, select DAB+ memory bank
 - 17 **FM1/FM2/FMT/AM** button
Directly choose FM1/FM2/FMT/AM
 - 18 Microphone
 - 19 On/Off button
Short press: Switch on car sound system
In operation: Mute car sound system (Mute)
Long press: Switch off car sound system
Turn: Change the Volume level
 - 20 **Balance** button
Rotate to change the Balance level

Safety notes

The car sound system was manufactured according to the state of the art and established safety guidelines. Even so, dangers may occur if you do not observe the safety notes in these instructions. These instructions contain important information to easily and safely install and operate the car sound system.

- Read these instructions carefully and completely before using the car sound system.
- Keep the instructions at a location so that they are always accessible to all users.
- Always pass on the car sound system to third parties together with these instructions.

In addition, observe the instructions of the devices used in conjunction with this car sound system.

Symbols used

These instructions employ the following symbols:



DANGER!

Warns about injuries



CAUTION!

Warns about damaging the CD drive



DANGER!

Warns about high volume



The CE mark confirms the compliance with EU directives.

➔ Identifies a sequencing step

- Identifies a listing

Road safety

Observe the following notes about road safety:

- **Use your device in such a way that you can always safely control your vehicle.** In case of doubt, stop at a suitable location and operate your device while the vehicle is standing.
- **Always listen at a moderate volume** to protect your hearing and to be able to hear acoustic warning signals (e.g. police sirens). During mute phases (e.g. when changing the audio source), changing the volume is not audible. Do not increase the volume during this mute phase.

General safety notes

Observe the following notes to protect yourself against injuries:

- **Do not modify or open the device.** The device contains a Class 1 laser that can cause injuries to your eyes.
- **Do not increase the volume during mute phases**, e.g. when changing the audio source. Changing the volume is not audible during a mute phase.

Use as directed

This car sound system is intended for installation and operation in a vehicle with 12 V vehicle system voltage and must be installed in a DIN slot. Observe the performance limits in the technical data. Repairs and installation, if necessary, should be performed by a specialist.

Installation instructions

You may only install the car sound system yourself if you are experienced in installing car sound systems and are very familiar with the electrical system of the vehicle. For this purpose, observe the installation instructions at the end of these instructions.

Declaration of conformity

The Blaupunkt Competence Center Car Multimedia Evo Sales GmbH declares that the device complies with the basic requirements and the other relevant regulations of the directive 2014/53/EU.

The declaration of conformity can be found on the Internet under www.blaupunkt.com.

Cleaning notes

Solvents, cleaning and scouring agents as well as dashboard spray and plastics care product may contain ingredients that will damage the surface of the car sound system.

- Use only a dry or slightly moistened cloth for cleaning the car sound system.
- If necessary, clean the contacts of the control panel regularly using a soft cloth moistened with cleaning alcohol.

Disposal notes



Do not dispose of your old unit in the household trash!

Use the return and collection systems available to dispose of the old device.

Scope of delivery

The scope of delivery includes:

- 1 Car sound system
- 1 Operating/installation instructions
- 1 Support frame
- 1 Antenna connection adapter
- 2 Disassembly tools
- 1 Spacer screw
- 1 Connecting cable chamber A (Optional)
- 1 Connecting cable chamber B (Optional)

Optional equipment (not part of the scope of delivery)

Use only accessories approved by Blaupunkt. Information is available from your Blaupunkt specialised dealer or on the Internet under www.blaupunkt.com.

Display language

- You can define whether the language for messages on the display is English or German. The setting is performed in the user menu (see the chapter "User settings", section "Making settings in the "DISPLAY" menu", menu item "LANGUAGE").

Important note for radio reception

This car sound system is designed for operation in different regions with different frequency ranges and station technologies. Available reception areas are "EUROPE", "ASIA", "USA", "SOUTH AMERICA" and "THAILAND".

You may have to set a suitable reception area first for the radio reception in the user menu (see the chapter "User settings", section "Making settings in the "TUNER" menu", menu item "TUNER AREA").

Switching on/off

Switching on/off with the On/Off button

- For switch-on, press the On/OFF button. The car sound system switches on.
- For switch-off the device, press and hold the On/OFF button longer than 2 seconds. The car sound system switches off.

Note:

If you switch on the car sound system while the vehicle ignition is switched off, it automatically switches off after 1 hour to preserve the vehicle battery.

Switching on/off via vehicle ignition

The car sound system will switch off/on simultaneously with the ignition if the device is correctly connected to the vehicle's ignition as shown in the installation instructions and you did not switch the device off by pressing the On/Off button.

Volume

Adjusting the volume

You can adjust the volume in steps from 0 (off) to 50 (maximum).

- Turn the VOL control to change the Volume.

Note:

If a telephone is connected with the car sound system as described in the installation instructions, the car sound system is muted in case of a phone call. During muting, the display shows "TELEPHONE".

Muting the car sound system (Mute)

- Briefly press the On/Off button to mute the car sound system or to reactivate the previous volume. While it is muted, the display shows "MUTE".

Traffic information

In the reception area "EUROPE", an FM station can identify traffic reports by means of an RDS signal. If priority for traffic reports is switched on, a traffic report is automatically switched through, even if the car sound system is currently not in radio mode.

If priority is switched on, the display shows the traffic jam symbol (). "TRAFFIC" is displayed during a switched-through traffic announcement. The priority is activated and deactivated in the user menu (see the chapter "User settings", section "Making settings in the "TUNER" menu", menu item "TRAFFICINFO").

Note:

The volume is increased for the duration of the switched-through traffic announcement. You can adjust the minimum volume for traffic

announcements (see the chapter "User settings", section "Making settings in the "VOLUME" menu", menu item "TRAFFIC VOL").

To cancel a switched-through traffic announcement, press the **SRC** button.

DAB mode

With DAB, you can enjoy radio in digital sound quality. In contrast with standard radio broadcasting, several programmes (services) are always broadcast over the same frequency for DAB. These services are combined into a so-called ensemble. In some cases, the same service can be received in different ensembles.

Note:

- You will need a special DAB antenna to be able to receive DAB signals. This can be a separate DAB roof/window antenna or a DAB/AM/FM combination antenna.

Changing to DAB mode or selecting a DAB memory bank

- Press the **DAB+** button repeatedly until the desired DAB memory bank is displayed: DAB1 >DAB2 >DAB3. If DAB mode is switched on, the display shows the symbol .

Notes:

- Up to 5 services can be stored in each DAB memory bank.
- DAB memory banks can be activated or deactivated via the user menu (see the chapter "User settings", section "Making settings in the "DAB TUNER" menu, "PRESETS" menu item). Deactivated DAB memory banks are skipped during the source selection with the **SRC** button.

Tuning into ensembles/services

With DAB, several services broadcast over the same frequency are always combined into an "ensemble".

Selecting an ensemble

You can directly select ensembles that you have received once already (for this to work, the ensemble must be receivable).

- Briefly press the Δ/∇ button to change to the previous/next ensemble. The first available service in the ensemble is played.

Note:

With activated PTY function, long press the Δ/∇ button to search the PTY programme type.

Ensemble seek tuning

You can find new ensembles using seek tuning.

- In DAB mode, seek starts with long press button \lll / \ggg .

Selecting a service

After you have tuned into an ensemble, you can select a service from the ensemble.

- For this briefly press $</>$ keys.

List selection

Services or ensembles, which have previously been received, can be selected directly in lists without interrupting the ongoing playback (for this purpose, the services/ensembles must be receivable).

- Long press **DAB+** button to enter to List selection.
- Press the button $<$ to display the list of all received ensembles. The display shows the current ensemble.
- Press the button Δ/∇ or hold the button to select a different ensemble.
- Press the button $>$ to display the services of the selected ensemble. The first service of the ensemble is shown on the display.

Note:

Press the button $<$ to return you to the list of ensembles.

- Press the button Δ/∇ once or several times or hold the button pressed to select a different service.
- Press the button $>$ to play back the service. The selected service is being played. You are exiting the list selection.

Saving a service or calling up a saved service

- Select the desired DAB memory bank.
- If necessary, set the desired service.
- Press the station button 1-5 for approx. 2 seconds to store the current service under the button
-or-
➤ Briefly press the station 1-5 to call up the stored service.

Scanning services

You can use the scan function to play all the receivable services briefly.

- Press the **MENU** button for approx. 2 seconds to start scanning. During the scanning, "SCAN" and the current service name are intermittently shown on the display.
- Briefly press the **MENU** button to continue listening to the service that is currently being scanned.

Refreshing services received

To update the received service, read the section "Making settings in the "DAB TUNER" menu", menu item "SERVICE SCAN" in the chapter "User settings".

Switching between DAB and FM

You can select various settings for switching between DAB and FM radio mode. Switching may become necessary if the reception quality in the DAB or FM mode drops significantly.

DAB-PTY

You can select a programme type with the PTY function to purposefully search for services, for example, that broadcast rock music or sport events.

Note:

- The PTY function is only available if it has been activated (see the chapter "User settings", section "Making settings in the "DAB TUNER" menu", menu item "PTY").

Selecting a programme type

To select a programme type, read the section "Making settings in the "DAB TUNER" menu", menu item "PTY TYPE" (programme type) in the chapter "User settings".

Searching for service

- ➡ Press the button Δ/∇ .
During the seek tuning, the currently selected programme type is shown on the display. As soon as a service with the desired programme type is found, it remains being tuned into.

Note:

- If no service with the selected programme type is found, "PTY NONE" is briefly displayed and 2 beeps can be heard. The radio will then retune to service that it played last.

Switching the display

- ➡ Press the button DIS to toggle between these displays .

Display	Meaning
ABCDEF	Service name
DLS mode	Dynamic Label Service
ABCDEF	Ensemble name
DAB1 5C or P1 5C	DAB memory bank/ frequency or Memory location/frequency
DAB1 18:30 or P1 18:30	DAB memory bank/time or Memory location/time

Radio mode RDS

Many FM stations broadcast an RDS (Radio Data System) signal in addition to their programme in the reception area "EUROPE" that allows the following additional functions:

- The station name is shown on the display.
- The car sound system recognises traffic announcements and news broadcasts and can automatically switch them through in other operating modes .
- Alternate frequency: If RDS is activated, the car sound system automatically selects the best receivable frequency for the station that is currently set.
- Regional: At certain times, some radio stations divide their programme into regional programmes providing different content. If the REGIONAL function is activated, the car sound system changes only to those alternate frequencies on which the same regional programme is being broadcast.
- Radio text information is shown on the display.

The functions RDS and REGIONAL are activated and deactivated in the user menu (see the chapter "User settings", section "Making settings in the "TUNER" menu", menu items "RDS AF" and "REGIONAL").

Note:

- If you adjust a different reception area than "EUROPE", RDS is automatically switched off. The station name continues to be shown on the display. If you want to use radio stations with RDS features in your region, switch on RDS in the user menu.

Changing to radio mode or selecting a memory bank

The following memory banks are available in the different reception areas:

Region	Memory banks
EUROPE	FM1, FM2, FMT, AM
ASIA	FM1, FM2, FMT, AM
USA	
SOUTH AMERICA	
THAILAND	

- ➡ Press the button **FM1>FM2>FMT>AM** to directly select desired memory bank is displayed.

Note:

- Up to 5 stations can be stored in each memory bank.

Tuning into a station

There are various ways of tuning into a station.

Starting station seek tuning

- ➡ Press the button **</>** to Auto search the station tuning.

Notes:

- For the reception area "EUROPE": In the FM waveband, only traffic information stations are turned into if the priority for traffic information () is switched on.
- The sensitivity of seek tuning can be adjusted. In FM setting, the sensitivity can be selected, Low or High.

Tuning into stations manually

- ➡ Press the button **◀◀/▶▶** to Manually search change the frequency in decrements/increments.

Storing stations or calling stored stations

- ➡ Select the desired memory bank.
- ➡ If necessary, set the desired station.
- ➡ Press the station button **1 - 5 >** for approx. 2 seconds to store the current station under the button.
- or -
- ➡ Briefly press the station button **1 - 5 >** to call up the stored station.

Scanning stations

With the scan function, you can scan either every receivable station or every stored station of the current waveband.

Note:

- You can adjust the scan time for each station (see the chapter "User settings", section "Making settings in the "VARIOUS" menu", menu item "SCAN TIME").

Scanning all receivable stations of the waveband

- ➡ Press the button **MENU** for approx. 2 seconds to start scanning. During the scan, the display alternately displays "SCAN" and the current frequency as well as memory bank or station name.

- Briefly press the button **MENU** to continue listening to the station that is currently.

Storing stations automatically (Travelstore)

With Travelstore, you can automatically search for and store the 5 FM stations offering the strongest reception in the region in the FMT memory bank. Any previously stored stations in this memory bank are deleted in the process.

In the reception areas "ASIA", "USA", "SOUTH AMERICA", and "THAILAND", you can also store 5 AM stations in the AMT memory bank.

- Select a memory bank of the desired waveband, e.g. FMT or AM.
- Press the **SRC** button for approx. 2 seconds. The tuner starts the automatic station seek tuning; the display shows "FM TSTORE". After the storing is completed, the radio plays the station at memory location 1 of the FMT or AMT level.

Note:

- For the reception area "EUROPE": If the priority for traffic information is switched on () , only traffic information stations are stored.
- If the FMT or AMT memory bank is deactivated (see the chapter "User settings", section "Making settings in the "TUNER" menu", menu item "BAND SELECTION"), it is automatically reactivated if

PTY you initiate the Travelstore function.

In the reception areas "EUROPE" and "USA", an FM station can transmit its current programme type, e.g. CULTURE, POP, JAZZ, ROCK, SPORT or SCIENCE. Hence, the PTY function allows a targeted search for broadcasts of a certain programme type, e.g. for rock or sports broadcasts. Note that PTY is not supported by all stations.

Note:

The PTY function is only available if it has been activated (see the chapter "User settings", section "Making settings in the "TUNER" menu", menu item "PTY").

Selecting a programme type

To select a programme type, read the section "Making settings in the "TUNER" menu", menu item "PTY TYPES" in the chapter "User settings".

Note:

In the reception area "EUROPE", you can adjust the language in which the programme types are displayed (see the chapter "User settings", section "Making settings in the "TUNER" menu", menu item "PTY LANGUAGE").

Searching for stations

Prerequisite: PTY function is switched on.

- Long press the Δ/∇ button to search the PTY programme type.

Note:

- If no station with the selected programme type is found, "NO PTY" is briefly displayed and 2 beeps can be heard. The radio will then retune to the station that it played last.
- If the tuned radio station or another station on the broadcasting network broadcasts your selected programme type at a later point in time, the car sound system will automatically switch from the currently tuned station or from the current audio source (e.g. USB) to the station whose programme type matches the one you selected. Note that this function is not supported by all stations.

Configuring the display

➤ Press the DIS button to toggle between the displays:

Display	Meaning
ABCDEF	Station name
RADIO TEXT	Radio text, only if available
P1 FM1 89.90	Memory location/ memory bank/frequency
P1 FM1 08:40	Memory location/ memory bank/time

Changing to MP3/WMA/iPod mode

➤ Press the **SRC** button repeatedly until the desired audio source is displayed:

- "SD(HC)": Inserted memory card
- "USB FRONT" or "USB REAR": USB data carrier connected to the front or rear.
- "IPOD FRONT / IPHONE FRONT" or "IPOD REAR / IPHONE REAR": Connected iPod / iPhone at the front or rear side
- "AUX": Connected external audio source.

iPod mode

You can connect numerous iPod and iPhone models to the car sound system via the USB port in the front of the device and the USB port at the rear and control the audio playback from the car sound system.

Note:

- A list of compatible iPod and iPhone models is located at the end of these instructions. Blaupunkt can not guarantee the flawless function of other iPod and iPhone models.
- If an iPhone and iPod are connected at the same time, the devices are charged via the USB ports. If two iPhones are connected at the same time, charging is not possible.

Use a suitable adapter cable to connect your iPod or iPhone with the USB port of the car sound system.

Connecting/removing a USB data carrier

Note:

- You can connect USB data carriers to the USB port at the front of the device as well as the rear USB port.

Connecting a USB data carrier

- Switch off the car sound system so that the data carrier will be correctly registered.
- First, pull the protective cap of the USB port : to the front until it moves out of the port and fold it to the right to connect a data carrier to the USB port at the front of the device.
- Connect the USB data carrier.
- Turn on the car sound system. If the USB data carrier is initially selected as audio source ,the data are read first.

Note:

- If the connected USB data carrier cannot be seen, "USB ERROR" is briefly displayed.
- The time required for reading in the data depends on the design and size of the USB data carrier.

MP3/WMA/iPod mode

Removing a USB data carrier

- Switched off the car sound system so that the data carrier will be correctly unregistered.
- Disconnect the USB data carrier.
- After you pulled off the data carrier from the USB port at the front of the device, close the protective cap of the USB port : .

Inserting/removing the memory card

- Open the USB cover.
- Insert the memory card with its labelled side up and its contacts first into the card slot until it clicks into place.
- After switch-on, the device automatically selects the inserted memory card as audio source. The data of the memory card are being read. Afterwards, the playback starts in MP3 mode.

Notes:

- If the inserted memory card cannot be played, "SD ERROR" is briefly displayed.
- The time required for reading the card depends on the design and size of the memory card.

Removing the memory card

- Push on the memory card until it disengages.
- Pull the memory card out of the card slot

Selecting tracks

- Press the button   or  to change to the previous /next track. Fast searching with long press   or  button. Press the button   to change folder during playback.

Notes:

- Press the button 1  and the display will show track name.
- Turn the rotary volume button to select your desired track.

- If the current track plays longer than 3 seconds and press 1  then you turn rotary control one notch counter-clockwise or clockwise, the tracks starts playing again.

Selecting a folder (in MP3/WMA mode only)

- Press the button 1  and long press the rotary control back to USB boot folder.
- Turn the rotary volume button to select your desired folder.

Notes:

- If you turn rotary control notches counter-clockwise or clockwise, you jump forward or reverse by the corresponding number of folders.

Interrupting playback

- Press the button  to interrupt the playback ("PAUSE") or to continue it.

Scanning all tracks (not in iPod mode)

The scan function scans all available tracks.

- Press the rotary control for approx. 2 seconds to start the scan, or briefly to continue playing the currently scanned track. During the scanning, "SCAN" and the file name are intermittently shown on the display.



Note:

The scan time can be adjusted (see the chapter "User settings", section "Making settings in the "VARIOUS" menu", menu item "SCAN TIME").

Repeatedly playing individual tracks or directories

➤ Press the **RPT** button to change among the playback modes:

Operation	Display	Meaning
iPod	REPEAT TRACK	Repeating tracks
MP3/ WMA	REPEAT TRACK	Repeating tracks
	REPEAT FOLDER	Repeating folders
Gen.	REPEAT OFF	Regular playback

If the REPEAT function is switched on, the icon  (repeat tracks) or  (repeat folders) is shown on the display.

Configuring the display

➤ Press the **DIS** button once or several times to toggle between these displays:

Operation	Display / icon	Meaning
MP3/ WMA/ iPod	PLAY TIME 00:15	Playing time
	TOTAL TIME 03:37	Track duration
	CLOCK 18:40	Time
	ALL INFO	All information as scrolling text

Note:

With every track change, the file name is briefly shown in MP3/WMA mode and the track name in iPod mode before the display switches to the defined display.

Browse mode

In browse mode, you can directly search for and select a certain track on the MP3/WMA data carrier or iPod without interrupting the current playback.

Browse mode in MP3/WMA mode

In MP3/WMA mode, you can select and play a track from a directory of the data carrier.

➤ Briefly press the **1**  button to call up the browse mode in MP3/WMA mode.

➤ The  icon flashes on the display. The currently playing track is shown.

Notes:

- The browse mode remains switched on for 5 minutes without confirming a selection.
- You can exit the browse mode at any time by pressing the **1**  button.

➤ Repeat the operating procedure until the desired track is selected.

Browse mode in iPod mode

In iPod mode, the tracks can be selected and played via categories.

➤ Briefly press the **1**  button to call up the browse mode in iPod mode.

Notes:

- The browse mode remains switched on for 5 minutes without confirming a selection.
- You can exit the browse mode at any time by pressing the **1**  button.

➤ Turn the rotary control to select the desired category and press the rotary control to confirm. The first folder of the selected category is shown on the display.

➤ Repeat the operating procedure until the desired track is selected. The playback starts. You are exiting the browse mode.

Searching by track names (not in iPod mode)

On MP3/WMA data carriers, you can find a track based on its file name and start the playback.

- Press the **1**  button for approx. 2 seconds to start the search function. You can now enter a file name with up to 16 characters:

Notes:

- You do not have to enter the complete file name. You can enter only the first characters of the file name and select the desired track from the list of tracks found.
 - You can exit the search function at any time by briefly pressing the **1**  button.
- Turn the rotary control to select a character for the respective position.
 - Briefly press the rotary control to go to the next position.
 - Press the rotary control for approx. 2 seconds to start the search. All tracks corresponding to the file name entered are listed.
 - If necessary, turn the rotary control to select a track.
 - Briefly press the rotary control to start the playback.

Bluetooth®

You can connect the car sound system via Bluetooth with other Bluetooth ready devices, such as cell phones or MP3 players. This allows you to use the car sound system with its integrated microphone as hand-free system for connected cell phones and control the audio output of other Bluetooth devices and play them back via loudspeakers of the car sound system (Bluetooth streaming).

If a navigation app is installed on a cell phone connected with the car sound system, you can play back the announcements of the navigation app simultaneously with one of the internal audio sources of the car sound system (e.g. radio). In addition, you can adjust the volume levels of both audio sources to each other. For further details, please read the sections "Activating/deactivating combined playback" and "Adjusting volume" in the chapter "Additional functions in the Bluetooth menu".

Note:

You can also connect an external microphone for hand-free calling (see the chapter "Installation instruction").

Bluetooth technology is wireless connection of short range. For this reason, Bluetooth devices must be located near the car sound system (in the vehicle) to establish and maintain a connection. To establish a Bluetooth connection, you must first pair the car sound system and the Bluetooth device. When you pair the devices, a Bluetooth connection is subsequently established automatically. This connection remains in effect as long as the Bluetooth device is within range. If the connection is interrupted, e.g. because you moved the cell phone outside the range, the connection is automatically re-established as soon as you are back within range.

You can connect 2 Bluetooth devices with the car sound system at the same time (Twin Connect). Two cell phones can be connected at the same time, but only one streaming device. If you connect a new device with car sound system, the connection to a currently connected device may automatically be interrupted. However, the car sound system leaves up to 5 different Bluetooth devices paired, and you can quickly and easily connect any of these devices with the car sound system again.

Bluetooth® menu

In the Bluetooth menu, you find all the functions for pairing, connecting and managing Bluetooth® devices.

Calling the Bluetooth® menu

- Briefly press the **MENU** button to open the user menu.
- Turn the rotary control until the "BLUETOOTH" menu item is selected.
- Press the rotary control to open the Bluetooth® menu.
- Turn the rotary control until the desired menu item is selected.
- Perform the setting (see the following sections).
- Briefly press the **MENU** button to exit the menu.

Notes:

- The Bluetooth® menu is automatically exited approx. 30 seconds after the last button activation and you are returned to the display of the current audio source.
- To go back to the next higher-level menu, turn the rotary control until the "<<<" option is selected and press the rotary control.
- If a Bluetooth® process is running (e.g. re-establishing the connection to the last connected device), the functions of the Bluetooth® menu are blocked. If you attempt to open the Bluetooth® menu during this time, "LINK BUSY" briefly appears on the display. If you want to cancel the Bluetooth® process and open the Bluetooth® menu, press the  button.

Pairing and connecting a device**Note:**

You can pair up to 5 Bluetooth® devices with this car sound system. Before you can pair a sixth device, you must first unpair one of the 5 already paired devices (see ch. "Additional functions in the Bluetooth® menu", section "Managing paired devices").

If you should attempt to pair a sixth Bluetooth® device, "PHONE LIST FULL – PLEASE DELETE ENTRIES FROM LIST" is displayed.

Pairing and connecting a cell phone**Note:**

If a connection with a cell phone currently exists, this connection is automatically disconnected if you pair and connect another cell phone.

- In the Bluetooth® menu, select the "PAIRING" menu item.
- Press the rotary control to open the menu. The "MOBILE PHONE" menu item is selected.
- Press the rotary control to register a cell phone.

The display intermittently shows "ENTER PIN" and the currently stored PIN (default "1234"). In addition, the Bluetooth® icon  flashes. The car sound system can now be recognised by a Bluetooth® cell phone for approx. 2 minutes and connected.

- Search the car sound system from your cell phone (Bluetooth® name) and establish the connection. Enter the PIN displayed by the car sound system, if necessary. The display may show "PAIRED", followed by "CONNECTED", as soon as the car sound system and the cell phone are paired and connected.

Note:

If no connection can be established, the display briefly shows "CONNECT FAILED".

Pairing and connecting a Bluetooth® streaming device**Note:**

If a connection with a streaming device currently exists, this connection is automatically disconnected if you pair and connect another streaming device.

- In the Bluetooth® menu, select the "PAIRING" menu item.
- Press the rotary control to open the menu. The "MOBILE PHONE" menu item is selected.
- Turn the rotary control to select the "STREAMING" menu item.
- Press the rotary control to register a streaming device. The display shows the currently stored PIN (default "1234"). If required, enter the PIN of the streaming device.
- Turn the rotary control to select a digit for the respective position.
- Press the rotary control to go to the next position.

Note:

Not all streaming devices require the entry of a PIN on the car sound system. For some streaming devices, you have to enter the PIN of the car sound system instead. For these devices, press only the rotary control repeatedly until you reach beyond the last position, enter this PIN on the streaming device. The display intermittently shows "ENTER PIN" and the currently stored PIN (default "1234"). In addition, the Bluetooth® icon  flashes. The car sound system can now be recognised by the streaming device for approx. 2 minutes and connected.

Bluetooth®

- Search the car sound system from your streaming device (Bluetooth® name) and establish the connection. Enter the PIN displayed by the car sound system, if necessary.

The display may show "PAIRED", followed by "CONNECTED", as soon as the car sound system and the streaming device are paired and connected.

Notes:

- If no connection can be established, the display briefly shows "CONNECT FAILED".
- If a Bluetooth® device is connected with the car sound system, the display shows the Bluetooth® icon .
- After switch-on, the car sound system automatically attempts to reconnect the device connected last. If the connection attempt fails, the display briefly shows "NODEVICE". If necessary, attempt to re-establish the connection from the Bluetooth® device.

Twin connect

If you want to connect two Bluetooth® devices with the car sound system at the same time, Twin Connect needs to be activated in the Bluetooth® menu (see the chapter "Additional functions in the Bluetooth® menu", section "Activating/deactivating Twin Connect"). If two cell phones are connected with the car sound system, one of the connected phones must be selected as master telephone (see the chapter "Additional functions in the Bluetooth® menu", section "Managing paired devices"). Upon activating Twin Connect, the currently connected telephone is automatically specified as master telephone. If no telephone is connected with the car sound system, the previously connected telephone is specified as master telephone. In the list of telephones, an asterisk symbol () is shown next to the Bluetooth® name of the master telephone.

Notes:

- Only the master telephone is used for outgoing calls.
- You can access only the phone book of the master telephone.
- You can select the other connected telephone as master telephone at any time.



Telephone functions

Answering/rejecting an incoming phone call

With an incoming call, the display alternately shows "INCOMING CALL" and the number of the caller. The current audio source is muted and a ring tone is played via the loudspeakers of the car sound system.

Note:

If the number of the caller is not being transmitted, the display shows "PRIVATE NUMBER" instead of the number. If the number of the caller is stored together with a name, the name of the entry and the number are displayed (see the section "Storing a phone number in the car sound system" in this chapter).

- Press the  button to answer the call. "CALL" and the duration of the ongoing call are displayed.
- Press the  button to reject the call or to end the current call. The display shows "CALL END".

Notes:

- During the call, you can adjust the volume with the volume control or mute the microphone and the loudspeakers with a short press to the On/Off button.
- You can preset the minimum volume for the call playback in the user menu (see the chapter "User settings", section "Making settings in the "VOLUME" menu", menu item "HANDSFREE VOL").
- You can switch the call playback back and forth between the loudspeakers of the car sound system and the cell phone with the  button.
- If another call is received during an ongoing phone call, the second call cannot be answered via the car sound system.
- If the car sound system is switched off with active ignition, it automatically switches on with an incoming call. This allows you to make the call over the hands-free system. After the call has ended, the car sound system automatically switches off again.

Bluetooth®

Making a call

- In the Bluetooth® menu, select the "DIAL NEW NUMBER" menu item.
- Press the rotary control to open the entry menu.
You can now enter a phone number with up to 20 digits:
- Turn the rotary control to select a digit for the respective position.
- Press the rotary control to go to the next position.

Note:

To return to the previous position in the entry menu, turn the rotary control until the "<" option is selected, and press the rotary control.

- Press the  button to call the number entered. "CALLING" and the dialed number are alternately shown on the display. As soon as your calling party answers the call, the display shows "CALL" and the time of the current phone call. Upon ending the call, the display briefly shows "CALL END".

Calling an entry in the phone book

Note:

This function is available only if the phone book of the connected cell phone was transferred to the car sound system (see the chapter "Phone book functions").

- In the Bluetooth® menu, select the "PHONEBOOK" menu item.

Press the rotary control to open the phone book.
The display shows first phone book entry.

Note:

If the phone book has not yet been transferred, the display briefly shows "PHONEBOOK NOT AVAILABLE".

- In the Bluetooth® menu, select the "PBSEARCH" (phone book search) menu item.

- Press the rotary control to open the entry menu.
- Turn the rotary control to select the first letter of the desired entry.
- Press the rotary control to confirm the selection.
The display shows first phone book entry that starts with the selected letter.

Note:

If the phone book does not contain any entry with the selected first letter, the display briefly shows "NOT FOUND".

- Turn the rotary control to select a different entry.
- Press the rotary control or the  button to call the number.
"CALLING" and the dialed number are alternately shown on the display.

Note:

You can also call an entry in the phone book via speed dial (see the section "Speed dial for phone book entries" in this chapter).

Making a call with voice dial

Note:

This function is only available if the connected cell phone supports voice dial.

- In the Bluetooth® menu, select the "VOICE DIAL" menu item.
- Press the rotary control or the  button to activate voice recognition. The car sound system is muted and the display shows "SPEAK NOW".
- Say the name of the desired calling partner.

Notes:

- If no Bluetooth® connection is established when voice recognition is activated, the display briefly shows "VOICE DIAL FAILED – NO BT CONNECTION".

- If the spoken name is not being recognised or the time for the voice recognition has already expired, the display briefly shows "DIAL FAILED".
- You can cancel the voice recognition by pressing the  button.
- Please note that the duration of the voice recognition is limited and depending on the respective cell phone.
- You can also activate the voice recognition via speed dial (see the section "Speed dial for voice dial" in this chapter).

Storing a phone number in the car sound system

You can store phone numbers in the car sound system and make calls using the speed dial (see the following section).

A phone number is stored for the currently connected telephone and is available only for this telephone. The car sound system can store up to five numbers for up to five paired devices.

- Enter the phone number as described in the section "Making a call".
- Press the desired memory button **1 - 5** > for approx. 2 seconds to store only the number.
- Press the rotary control for approx. 2 seconds to enter a name for the entry. You can now enter a name with up to 15 characters.
- Turn the rotary control to select a character for the respective position.
- Press the rotary control to go to the next position.

Note:

To return to the previous position in the entry menu, turn the rotary control until the "<" option is selected, and press the rotary control.

- Press the desired memory button > for approx. 2 seconds to store the number and name.
- The display briefly shows "NUMBER SAVED". Afterwards, you are returned to the Bluetooth® menu and the "DIAL NEW NUMBER" menu item.

Notes:

- A number previously stored on the memory button is replaced.
- If a telephone is unpaired, the numbers stored for this telephone are automatically deleted.

Speed dial for any phone number or for the number dialed last or a stored number

With speed dial, you can make a call without first having to select the corresponding function in the Bluetooth® menu.

To call the number dialed last, press the  button. The display shows the number dialed last.

Note:

If no cell phone is currently connected, the Bluetooth® menu is opened. The "PAIRING" menu item is selected.

Press the  button to call the number. "CALLING" and the dialed number are alternately shown on the display.

To call a stored number, press the  button.



Press a memory button **1 - 5** > to call the number stored.

Note:

If no number is stored under the selected memory button, the display briefly shows "NO NUMBER".

Press the  button to call the number. "CALLING" and the dialed number are alternately shown on the display.

To call any number,

- press the  button.
- Press the rotary control to open the entry menu and enter a number (enter the phone number as described in the section "Making a call").
- Press the  button to call the number. "CALLING" and the dialed number are alternately shown on the display.

Bluetooth®

Speed dial for phone book entries

Note:

This function is only available

- if the phone book of the connected cell phone was transferred to the car sound system (see the chapter "Phone book functions").
- if the speed dial is set for phone book entries (see the chapter "Additional functions in the Bluetooth® menu", section "Setting the button function for speed dial").

To select an entry of the phone book with the speed dial and call it, press the  button for approx. 2 seconds.

The display shows the first phone book entry or the search function for phone book entries.

If necessary, select another entry as described in the section "Calling an entry in the phone book".

Press the  button to call the number. "CALLING" and the dialed number are alternately shown on the display.

Speed dial for voice dial

Note:

This function is only available

- if the connected cell phone supports voice dial.
- if the speed dial is set for voice dial (see the chapter "Additional functions in the Bluetooth® menu", section "Setting the button function for speed dial").

To activate the voice recognition with the speed dial,

➤ press the  button for approx. 2 seconds.

The car sound system is muted and the display shows "SPEAK NOW".

➤ Say the name of the desired calling partner.

Bluetooth® streaming mode

You can play back music from a Bluetooth® audio device via the loudspeakers of the car sound system if the audio device supports the Blue-

tooth® profile A2DP (Advanced Audio Distribution Profile).

Starting the Bluetooth® streaming mode

➤ Press the **SRC** button repeatedly until "BT-STREAM" appears on the display. The playback starts.

Notes:

- The Bluetooth® streaming mode can be selected only if a suitable streaming device is connected.
- If the connection to the streaming device is lost during playback, the display briefly shows "CONNECTION LOST" and the car sound system changes to the previous audio source.
- If a call is received during the music playback, the playback is interrupted and continued after the call.

Selecting tracks

➤ Press the button  to change to the previous /next track.
or

➤ Press the button  to change to the previous /next track.
or

➤ Press the button  to change to the previous /next track.

Interrupting playback

➤ Press the button  to interrupt the playback ("PAUSE") or to continue it.

Phone book functions

Transferring the phone book of the cell phone to the car sound system

You can transfer the phone book of the connected cell phone to the car sound system to call entries of the phone book using the car sound system

Notes:

- The car sound system accepts only entries from the memory of the telephone and not from the SIM card inserted in the telephone.

- The transfer does not delete the phone book from the cell phone.
- You can access the phone book of the master telephone only if two cell phones are simultaneously connected with the car sound system.

The car sound system can store the phone books of the paired telephones with a total of up to 1000 entries. If several numbers are stored on the telephone for one contact (e.g. landline, cell phone number, office number and similar), each number is stored as a separate entry by the car sound system.

Each entry consists of a name and a number, each up to 20 characters on digits.

Note:

Do not switch off the car sound system while transferring the phone book. If you do or if the power supply of the car sound system should be interrupted for any reason, you have to restart the transfer.

- In the Bluetooth® menu, select the "DOWN-LOAD P-BOOK" menu item.
- Press the rotary control and display shows "PLEASE CONFIRM".
- Press the rotary control again.

"PHONEBOOK DOWNLOADING-PLEASE WAIT" appears on the display.

After the download is complete, the display briefly shows "DOWNLD COMPLETE".

Notes:

- To cancel the transfer, press the  button.
- If the transfer of the phone book fails, the display briefly shows "DOWNLOAD FAILED".
- If the transfer of the phone book exceeds the storage capacity of the car sound system, the display briefly shows "PHONE-BOOK FULL". The phone book entries transferred so far remain stored.

- If you supplemented or changed entries on your cell phone since the last transfer, you can update the phone book on the car sound system by transferring it again. If the storage capacity of the car sound system is exceeded in the process, first delete the already transferred phone book (see the next section) or unpair another cell phone, if necessary, so that its phone book is also deleted from the car sound system (see the chapter "Additional functions in the Bluetooth® menu", section "Managing paired devices").

Deleting the phone book of the cell phone from the car sound system

You can delete the phone book of the connected cell phone.

Note:

The telephone remains connected.

- In the Bluetooth® menu, select the "DELETE P-BOOK" menu item.
- Press the rotary control and display shows "PLEASE CONFIRM".
- Press the rotary control again and display briefly shows "EMPTY LIST".

Additional functions in the Bluetooth® menu

Activating/deactivating twin connect

Activate/deactivate twin connect (two Bluetooth® devices can simultaneously be connected with the car sound system).

- In the Bluetooth® menu, select the "TWIN CONNECT" menu item.
- Press the rotary control to change the setting.
- Turn the rotary control to toggle between the settings ON and OFF.
- Press the rotary control to confirm the setting.

Changing the Bluetooth® PIN

The factory-set Bluetooth® PIN of the car sound system is "1234"; e.g. it must be entered on the cell phone when pairing a cell phone. This PIN can be changed.

- In the Bluetooth® menu, select the "PIN EDIT" menu item.
- Press the rotary control to open the entry menu.

The current PIN is shown on the display.

Bluetooth®

- Press the rotary control again. You can now enter the PIN:
- Turn the rotary control to select a digit for the respective position.
- Press the rotary control to go to the next position.

Managing paired devices

In the Bluetooth® menu, you can manage the paired Bluetooth® devices (cell phones and streaming devices such as MP3 player).

In the device lists for cell phones and streaming devices, the Bluetooth® names of the paired devices are displayed. You can do the following:

- Disconnecting the connection to the currently connected Bluetooth® device
- Establishing a connection to one of the paired Bluetooth® devices
- Unpairing Bluetooth® devices
- Select master telephone (for Twin Connect)

➤ In the Bluetooth® menu, select the menu item "PHONE LIST" or "STREAMING LIST".

➤ Press the rotary control to open the menu. The first device on the list is displayed.

Note:

If no device is paired, "EMPTY LIST" is briefly displayed.

➤ Turn the rotary control to select a different device or the "DELETE ALL" option. You have the following options to connect the displayed device:

➤ press the  button

- or -

➤ Press the rotary control to open the menu.

➤ Select the "CONNECT" menu item.

Note:

The "CONNECT" menu item is shown only if the device is not connected.

As soon as the device is connected, "CONNECTED" is briefly displayed and you are returned to the device list.

Note:

If no connection can be established, the display briefly shows "CONNECT FAILED". If the device is already connected, the display briefly shows "CONNECT EXIST".

To disconnect the connection to the displayed device,

➤ press the  button

- or -

➤ Press the rotary control to open the menu.

➤ Select the "DISCONNECT" menu item.

Note:

The "DISCONNECT" menu item is shown only if the device is connected. The display briefly shows "DISCONNECTED" and you are returned to the device list.

Note:

If the device was not connected, the display briefly shows "NO CONNECTION".

To unpair the displayed device,

➤ press the  button for approx. 2 seconds.

- or -

➤ Press the rotary control to open the menu.

➤ Select the "DELETE" menu item.

➤ Press the rotary control and the display briefly shows "DELETED" and you are returned to the device list.

Note:

If a telephone is unpaired, the numbers stored for this telephone and a phone book transferred from this cell phone are automatically deleted.

To select the device shown as master telephone,

- press the rotary control to open the menu.
- Select the "SET AS MASTER" menu item.

Note:

The "SET AS MASTER" menu item is shown only if two cell phones are simultaneously connected with the car sound system.

- Press the rotary control and you are returned to the device list, and an asterisk symbol (*) is shown next to the Bluetooth® name of the device.

To unpair all the cell phones or streaming devices,

- select the "DELETE ALL" menu item.
- Press the rotary control and the display shows "PLEASE CONFIRM".
- Press the rotary control again.

The display briefly shows "EMPTY LIST".

Setting the button function for speed dial

You can select whether the long press of the  button directly opens the phone of the search function for phone book entries or activates voice dialing.

- In the Bluetooth® menu, select the "SOFTKEY" menu item.
- Press the rotary control to change the setting.
- Turn the rotary control to toggle between the settings "SEARCH" (for search function), "P-BOOK" (for phone book) and "VOICE" (for voice dial).
- Press the rotary control to confirm the setting.

Adjusting the mode for Bluetooth® streaming mode

For the music playback, select between Bluetooth® streaming device or Android cell phone with app control.

- In the Bluetooth® menu, select the "BT MUSIC mode" menu item.
- Press the rotary control to open the menu.
- Turn the rotary control to change between the settings "STREAMING MODE" (for streaming devices) and "APP MODE" (for Android cell phones with app control).

- Press the rotary control to confirm the setting.

Activating/deactivating combined playback

Prerequisite: The cell phone must be connected with the car sound system as a streaming device. With the setting ON, navigation announcements of the connected cell phone are played back simultaneously with the respective active internal audio source of the car sound system (e.g. radio).

- In the Bluetooth® menu, select the "BT NAVI MIX" menu item.
- Press the rotary control to change the setting.
- Turn the rotary control to toggle between the settings ON and OFF.
- Press the rotary control to confirm the setting.

Adjusting volume

Only possible with activated combined playback (BT NAVI MIX ON): This setting allows raising or lowering the level of the navigation announcements to adjust it to the level of the other active audio source. Settings: -5 to +5.

- In the Bluetooth® menu, select the "BT NAVI GAIN" menu item.
- Press the rotary control to change the setting.
- Turn the rotary control to set the level adjustment.
- Press the rotary control to confirm the setting.

External audio sources

Front AUX-IN socket



Danger!

Increased risk of injury from connector.

In case of an accident, the protruding connector in the front AUX-IN socket may cause injuries. The use of straight plugs or adapters leads to an increased risk of injury.

For this reason, it is recommended to use angledjack plugs.

As soon as an external audio source, such as a portable MP3 player is connected to the front AUX-IN socket, it can be selected with the SRC button."AUX" then appears on the display.

Sound settings

The following sound settings can be changed in the "AUDIO" menu:

- Adjusting bass and treble
- Setting the left/right volume distribution (Balance) or front/rear (Fader)
- Adjusting the increase of bass at low volume (Loudness)
- Selecting a sound profile
- Selecting level and frequency of the preamplifier output (Sub-Out).
- Adjusting the time delay for switching in an external amplifier.
- Setting the 3-band equaliser

Calling and exiting the "AUDIO" menu

- Briefly press the **MENU** button to open the user menu.
- Turn the rotary control until the "AUDIO" menu item is selected.
- Press the rotary control to open the "AUDIO" menu.
- Turn the rotary control until the desired menu item is selected.
- Perform the setting (see the next section).
- Briefly press the **MENU** button to exit the menu.

Notes:

- The menu is automatically exited approx. 15 seconds after the last button activation and you are returned to the display of the current audio source.
- To go back to the next higher-level menu, turn the rotary control until the "<<<" option is selected and press the rotary control.

Making settings in the "AUDIO" menu

BASS

Bass level. Settings: -7 to +7.

- Rotary bass control to change the setting until the desired level is set.

TREBLE

Bass level. Settings: -7 to +7.

- Rotary treble control to change the setting until the desired level is set.

BALANCE

Left/right BALANCE distribution. Settings: L9 (left) to R9(right).

- Rotary balance control to change the setting until the desired volume distribution is set.

FADER

Front/Rear FADER distribution. Settings: F9 (front) to R9(rear).

- Press the rotary control to change the setting.
- Turn the rotary control to change between the settings.
- Press the rotary control to confirm the setting.

LOUDNESS

Increase of bass at low volume. Settings: ON, OFF.

- Press the rotary control to change the setting.
- Turn the rotary control to change between the settings.
- Press the rotary control to confirm the setting.

PRESET EQ (sound profile)

Selecting equalizer presettings. Settings: POP, ROCK, CLAS (classic), OFF (no presetting).

- Press the rotary control to change the setting.
- Turn the rotary control to change between the settings.
- Press the rotary control to confirm the setting.

SUB-OUT

Setting the level and frequency of the preamplifier output.

- Press the rotary control to open the menu.
- Turn the rotary control to change between the following menu items:
 - FREQUENCY (settings: 80/120/160 Hz)
 - GAIN (settings: 0 to +7)

- Press the rotary control to change the setting for the selected menu item.
- Turn the rotary control to set the level or frequency.
- Press the rotary control to confirm the setting.

AMP DELAY

Setting the delay with which a connect amplifier is switched in. Settings: 0.5/1.0/1.5/2.0/2.5 seconds and OFF (no delay).

- Press the rotary control to change the setting.
- Turn the rotary control until the desired delay is set.
- Press the rotary control to confirm the setting.

Setting the 3-band equaliser

The radio features a 3-band equaliser. For each of the three treble, middle and bass bands, you can select a frequency as well as adjust the level. In addition, you can adjust the quality factor for bass and middle. The equaliser also provides an adjustable increase of the bass at low volume (X-bass).

Opening the "EQUALIZER" menu

- In the "AUDIO" menu, select the "EQUALIZER" menu item.
- Press the rotary control to open the menu.
- Turn the rotary control to change between the following menu items:
 - EQUALIZER
 - EQ TREBLE
 - EQ MIDDLE
 - EQ BASS
 - EQ X-BASS

Note:

The submenus in the "EQUALIZER" menu are not automatically exited after the last key has been activated. After the setting, press the **MENU** button to exit the menu.

EQUALIZER

Switching the equalizer on or off. Settings: ON, OFF.

- Press the rotary control to change the setting.
- Turn the rotary control to change between the settings.
- Press the rotary control to confirm the setting.

EQ TREBLE

Adjusting treble frequency and level of the equalizer.

- Press the rotary control to open the menu.
- Turn the rotary control to change between the following menu items:
 - FREQUENCY (settings: 10/12.5/15/17.5 kHz)
 - GAIN (settings: -7 to +7)
- Press the rotary control to change the setting for the selected menu item.
- Turn the rotary control to set the level or frequency.
- Press the rotary control to confirm the setting.
- Press the rotary control to confirm the setting.

EQ MIDDLE

Adjusting centre frequency and level of the equalizer.

- Press the rotary control to open the menu.
- Turn the rotary control to change between the following menu items:
 - FREQUENCY (settings: 0.5/1.0/1.5/2.5 kHz)
 - GAIN (settings: -7 to +7)
 - Q-FACTOR (settings: 0.5/0.75/1.0/1.25)
- Press the rotary control to change the setting for the selected menu item.
- Turn the rotary control to set the level, frequency or Q-factor.
- Press the rotary control to confirm the setting.

EQ BASS

Adjusting bass frequency and level of the equalizer.

- Press the rotary control to open the menu.
- Turn the rotary control to change between the following menu items:
 - FREQUENCY (settings: 80/100/200 Hz)
 - GAIN (settings: -7 to +7)
 - Q-FACTOR (settings: 1.0/1.25/1.5/2.0)
- Press the rotary control to change the setting for the selected menu item.
- Turn the rotary control to set the level, frequency or Q-factor.
- Press the rotary control to confirm the setting.

EQ X-BASS

Adjusting the frequency and level for the increase of bass at low volume.

- Press the rotary control to open the menu.
- Turn the rotary control to change between the following menu items:
 - FREQUENCY (settings: 60/80/100 Hz)
 - GAIN (settings: 0 to +3)
- Press the rotary control to change the setting for the selected menu item.
- Turn the rotary control to set the level or frequency.
- Press the rotary control to confirm the setting.

User settings

Calling the user menu and selecting a menu

- Briefly press the **MENU** button to open the user menu. In the user menu, the user settings can be found in the following menus:

- FM TUNER
- DAB TUNER
- AUDIO (see chapter "Sound settings")
- DISPLAY
- VOLUME
- CLOCK
- VARIOUS
- BLUETOOTH (see the chapter "Bluetooth®")
- Turn the rotary control to until the desired menu is selected.
- Press the rotary control to open the selected menu.
- Turn the rotary control until the desired menu item is selected.
- Perform the setting (see the following sections).
- Briefly press the **MENU** button to exit the menu.

Notes:

- The menu is automatically exited approx. 15 seconds after the last button activation and you are returned to the display of the current audio source.
- To go back to the next higher-level menu, turn the rotary control until the "<<<" option is selected and press the rotary control.

Making settings in the "FM TUNER" menu

TRAFFIC (traffic information) (only for reception area EUROPE)

Only possible in FM radio mode: Switching priority for traffic announcements on or off. Settings: ON,OFF

- Press the rotary control to change the setting.
- Turn the rotary control to change between the settings.
- Press the rotary control to confirm the setting.

If priority is switched on for traffic information, the display shows the icon .

REGIONAL (only for reception area EUROPE)

Only possible in FM radio mode: Switching REGIONAL function on/off.

Settings: ON,OFF

- Press the rotary control to change the setting.
- Turn the rotary control to change between the settings.
- Press the rotary control to confirm the setting.

SENSITIVITY

Setting the sensitivity of station seek tuning. Settings: LO (low), HI (high).

- Press the rotary control to change the setting.
- Turn the rotary control to change between the settings.
- Press the rotary control to confirm the setting.

HIGH CUT

Setting the value of highcut. Settings: OFF,1,2,3

- Press the rotary control to change the setting.
- Turn the rotary control to change between the settings.
- Press the rotary control to confirm the setting.

RDS

Switching the RDS function on or off. Settings: ON, OFF

- Press the rotary control to change the setting.
- Turn the rotary control to change between the settings.
- Press the rotary control to confirm the setting.

Note:

If the reception area "ASIA", "USA", "SOUTH AMERICA" or "THAILAND" is selected, RDS is automatically switched off. The station name continues to be shown on the display.

PTY

Switching the PTY function on or off. Settings: ON, OFF

- Press the rotary control to change the setting.
- Turn the rotary control to change between the settings.
- Press the rotary control to confirm the setting.

PTY TYPES

Only possible with activated PTY function: Select a programme type.

Note:

As soon as a programme type has been selected, this programme type is shown as menu item in the menu instead of "PTY TYPES".

- Press the rotary control to change the setting.
- Turn the rotary control to change between the available programme types.
- Press the rotary control selected programme type.

PTY LANGUAGE (only for reception area EUROPE)

Only possible with activated PTY function: Select a language for the display of the programme types. Settings: ENGLISH, DEUTSCH (German), FRANCAIS (French).

- Press the rotary control to open the menu.
- Turn the rotary control to change between the languages.
- Press the rotary control to confirm the selected language.

TUNER AREA (reception area)

Select the reception area for the radio reception. Settings: EUROPE, ASIA, USA, SOUTH AMERICA, THAILAND.

- Press the rotary control to open the menu.
- Turn the rotary control to change between the reception areas.
- Press the rotary control to select a reception area. The display shows "PLEASE CONFIRM".
- Press the rotary control to confirm selected reception area.

Making settings in the "DAB TUNER" menu**ANT (ANTENNA)**

Switching the DAB antenna 12 volts power supply on or off.

Settings: ON, OFF

- Press the rotary control to change the setting.
- Turn the rotary control to change between the settings.
- Press the rotary control to confirm the setting.

User settings | Making setting in the "VOLUME" menu

SERVICE SCAN

Start to DAB service scan.

- Press the rotary control and the display show CONFIRM.
- Press again to start service scan.

SERVICE LINK

Select the service link type. Settings: OFF,ALL,DAB,FM

- Press the rotary control to change the setting.
- Turn the rotary control to change between the settings.
- Press the rotary control to confirm setting.

PRESET

Select the PRESET of DAB2 or DAB 3. Settings: DAB2 : ON,OFF, DAB3: ON,OFF

- Press the rotary control to change the setting.
- Turn the rotary control to change between the settings.
- Press the rotary control to confirm setting.

PTY (DAB)

Switching the DAB PTY function on or off. Settings: ON,OFF.

- Press the rotary control to change the setting.
- Turn the rotary control to change between the settings.
- Press the rotary control to confirm setting.

SERVICE NAME

Select the SERVICE NAME digit number. Settings: DIGIT 8, DIGIT 16.

- Press the rotary control to change the setting.
- Turn the rotary control to change between the settings.
- Press the rotary control to confirm setting.

Making settings in the "DISPLAY" menu

DIMMER

Select automatic or manual switching of the display brightness for day or night. Settings: AUTO (display brightness is automatically switched by switching the driving lights on or off), MANUAL (display brightness can be switched manually).

- Press the rotary control to change the setting.
- Turn the rotary control to change between the settings.
- Press the rotary control to confirm setting.

Automatic switching of the display brightness is possible only if your car sound system is installed as described in the installation instructions and your vehicle features the corresponding connection.

SCROLLING

Select the display of scrolling text (e.g. when displaying MP3 file names with more than 15 characters) either as single display or continued display. Settings: 1X (single display), ON (continued display).

- Press the rotary control to change the setting.
- Turn the rotary control to change between the settings.
- Press the rotary control to confirm setting.

LANGUAGE

Select the language for the display. Settings: ENGLISH, DEUTSCH (German).

- Press the rotary control to change the setting.
- Turn the rotary control to change between the settings.
- Press the rotary control to confirm setting.

DAY

Change the panel illumination of day mode brightness value. Settings:01-16.

- Press the rotary control to change the setting.
- Turn the rotary control to change between the settings.
- Press the rotary control to confirm setting.

NIGHT

Select the panel illumination for night mode brightness value.
Settings:01-16.

- Press the rotary control to change the setting.
- Turn the rotary control to change between the settings.
- Press the rotary control to confirm setting.

COLOR

Change the panel illumination color .

You can change the R(REDF), G(GREEN),B(BLUE) value to change the illumination color.

- Press the rotary control to change " R " setting.
- Turn the rotary control to change the value between 0-8.
- Press the rotary control to confirm setting.

then

- Press the rotary control to change " G " setting.
- Turn the rotary control to change the value between 0-8.
- Press the rotary control to confirm setting.

then

- Press the rotary control to change " B " setting.
- Turn the rotary control to change the value between 0-8.
- Press the rotary control to confirm setting.

Note:

There are 729 colors can be selected for panel illumination through changing the R/G/B value.

Making settings in the "VOLUME" menu

ON VOLUME

Setting the power-on volume. Settings: ON VOLUME (power-in volume; 1-50) or LAST VOLUME (volume set last before switching off the car sound system).



Danger!
High volume

The power-on volume can be unexpectedly high if the LAST VOLUME setting is selected and a high volume was set the last time the radio was switched off.

Always set the device to a moderate volume.

-
- Press the rotary control to open the menu.
 - Turn the rotary control to switch between the menu items "LAST VOLUME" and "ON VOLUME" (power-on volume).

Upon selecting "LAST VOLUME":

- Press the rotary control twice to confirm the setting.

Upon selecting "ON VOLUME":

- Press the rotary control to change the setting.
- Turn the rotary control to set the volume.
- Press the rotary control to confirm the setting.

Setting the minimum volume for traffic information

TRAFFIC VOL (traffic information volume) (reception area EUROPE only)

Setting the minimum volume for traffic announcements. Settings: 1 – 50.

- Press the rotary control to change the setting.
- Turn the rotary control to set the volume.
- Press the rotary control to confirm the setting.

HANDSFREE VOL

Adjusting the minimum volume for telephone calls. Settings: 1 – 50.

- Press the rotary control to change the setting.
- Turn the rotary control to set the volume.
- Press the rotary control to confirm the setting.

Note:

During the phone call, you can change the volume directly by means of the volume control.

BEEP (button beep)

Switching the confirmation beep on or off Settings: ON, OFF.

Note:

When storing radio stations, a confirmation beep sounds even if the OFF setting is selected.

- Press the rotary control to change the setting.
- Turn the rotary control to change between the settings.
- Press the rotary control to confirm the setting.

Making settings in the "CLOCK" menu

PERM CLOCK

Switching the permanent display on or off Settings: ON, OFF.

- Press the rotary control to change the setting.
- Turn the rotary control to change between the settings.
- Press the rotary control to confirm the setting.

If the permanent display of the time is switched on, the time is shown on the display. The display of the respective audio source is shown only after pressing a button. Approximately 15 seconds after the button is pressed last, the time is displayed again.

HOURLY MODE

Selecting the 12 or 24-hour time. Settings: 12, 24.

- Press the rotary control to change the setting.
- Turn the rotary control to change between the settings.
- Press the rotary control to confirm the setting.

SET

Setting the time.

- Press the rotary control to change the setting.
- Turn the rotary control clockwise to set the hours.
- Turn the rotary control counter-clockwise to set the minutes.
- Press the rotary control to confirm the time setting.

Note:

When you set the time in 12-hour mode (HOUR MODE 12), an "AM" is displayed before the time for the time before noon or a "PM" for the time after noon.

RDS CLOCK (automatic time setting) (only for reception area EUROPE)

Switching automatic clock setting with clock data transmitted via RDS on or off. Settings: ON, OFF.

Note:

The time set with the clock data may not be correct, even if an RDS station is being received.

- Press the rotary control to change the setting.
- Turn the rotary control to change between the settings.
- Press the rotary control to confirm the setting.

Making settings in the "VARIOUS" menu

DEMO MODE

Switching the DEMO mode on or off. Settings: ON, OFF.

- Press the rotary control to change the setting.
- Turn the rotary control to change between the settings.
- Press the rotary control to confirm the setting.

In demo mode, the features of the radio are shown as scrolling text on the display.

SCAN TIME

Setting the scan time in seconds. Settings: 4/8/12/16/60 seconds.

- Press the rotary control to change the setting.
- Turn the rotary control clockwise to set the hours.
- Turn the rotary control counter-clockwise to set the minutes.
- Press the rotary control to confirm the time setting.

SWC(Steering Wheel Conguration)

Configuring the buttons of a connected steering wheel control.

- Press the rotary control to open the menu.
- Turn the rotary control to change between the functions.
- Press the rotary control to select a function.
- Press the corresponding button on the steering wheel control for approx. 1 second to program the button with the selected function.

VERSION

Displaying the current software version of the radio.

- Press the rotary control to open the menu.
- Turn the rotary control to display the version number of the current software.

NORMSET

Restoring the original factory settings of the car sound system.

- Press the rotary control and the display shows "PLEASE CONFIRM".
- Press the rotary control again to confirm the resetting.
The car sound system switches off and is reset to the factory settings.

Factory settings

Important factory settings in the user menu:

Menu item	Factory setting
TUNER AREA	EUROPE
HICUT	1
RDS	ON
REGIONAL	OFF
TRAFFICINFO	OFF
SENSITIVITY	HI
PTY	OFF
TRAFFIC VOL	20
BEEP	ON
SCAN TIME	8 SEC
DIMMER	MANUAL
HOUR MODE	24
CLOCK SET	00:00

In the user menu, you can restore the original factory settings of the car sound system (see the chapter "User settings", section "Making settings in the "VARIOUS" menu", menu item "NORMSET").

Useful information

Warranty

The warranty terms can be called up from www.blaupunkt.com.

Service

If you ever need to use a repair service you will find information about service partners in your country under www.blaupunkt.com.

Technical data

Voltage supply

Operating voltage: 10.5 – 14.4 V

Current consumption

In operation: <10A
10 sec. after switch-off: < 3.5mA

Amplifier

Output power: 4 x 24 watts sine at
14.4 V at 4 ohms.
4x50 watts max.p

Tuner

Wavebands in Europe/Asia/Thailand:

FM: 87.5 – 108 MHz

AM (MW): 531 – 1,602 kHz

Wavebands in the US:

FM: 87.7 – 107.9 MHz

AM (MW): 530 – 1,710 kHz

Wavebands in South America:

FM: 87.5 – 107.9 MHz

AM (MW): 530 – 1,710 kHz

FM frequency response: 30 – 15,000 Hz

4 channels: 4 V

Input sensitivity

MIC: 300 mV / 10 kΩ

Dimensions and weight

W x H x D: 178 x 50 x 110 mm

Weight: approx. 0.85 kg

EN Installation instructions Safety instructions

When carrying out installation work and making connections please observe the following

Disconnect the negative terminal of the battery! When doing so, please observe the vehicle manufacturer's safety instructions.

Make sure you do not damage vehicle components when drilling any holes.

The cross sections of the positive and negative cables must not be less than 1.5 mm².

Do not connect the vehicle's plug connectors to the radio!

You can obtain the adapter cable required for your vehicle type from any BLAUPUNKT dealer.

Depending on the model, your vehicle may differ from the description provided here. We accept no responsibility for any damages due to incorrect installation or connection or for any consequential damages.

If the information provided here is not suitable for your specific installation requirements, please contact your Blaupunkt dealer, your vehicle manufacturer or our telephone hotline.

When installing an amplifier, you must first connect the device earth connections before connecting the plugs for the line-out jacks.

Earth connection of external devices may not be connected to earth of car sound system (housing).

Installation instructions

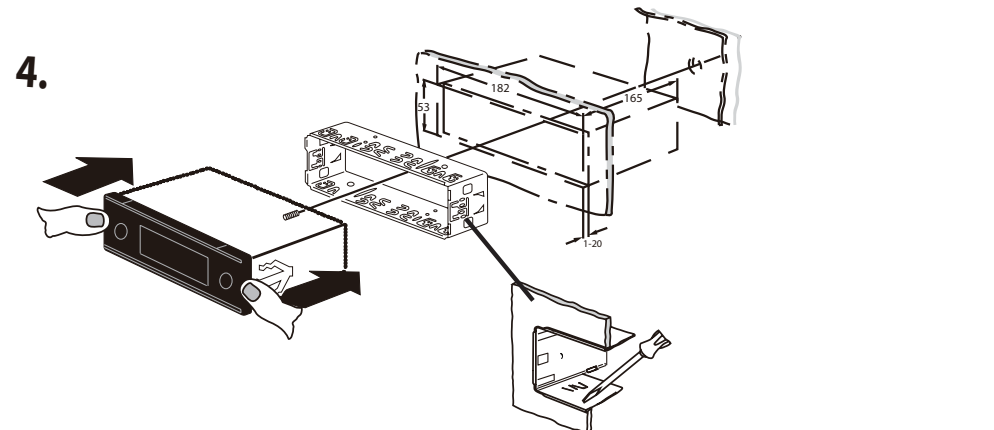
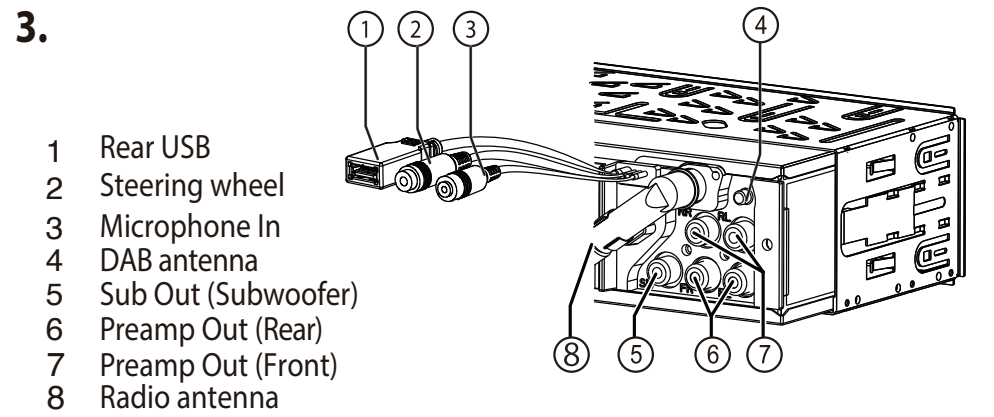
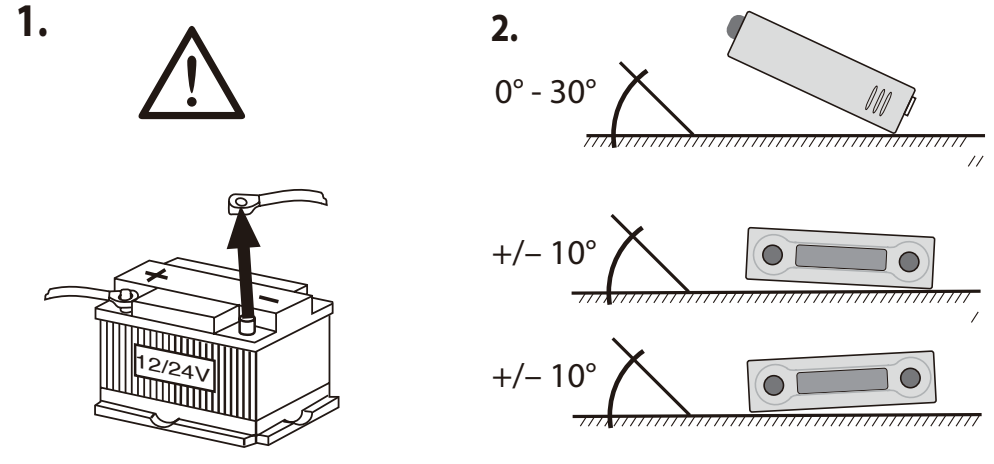
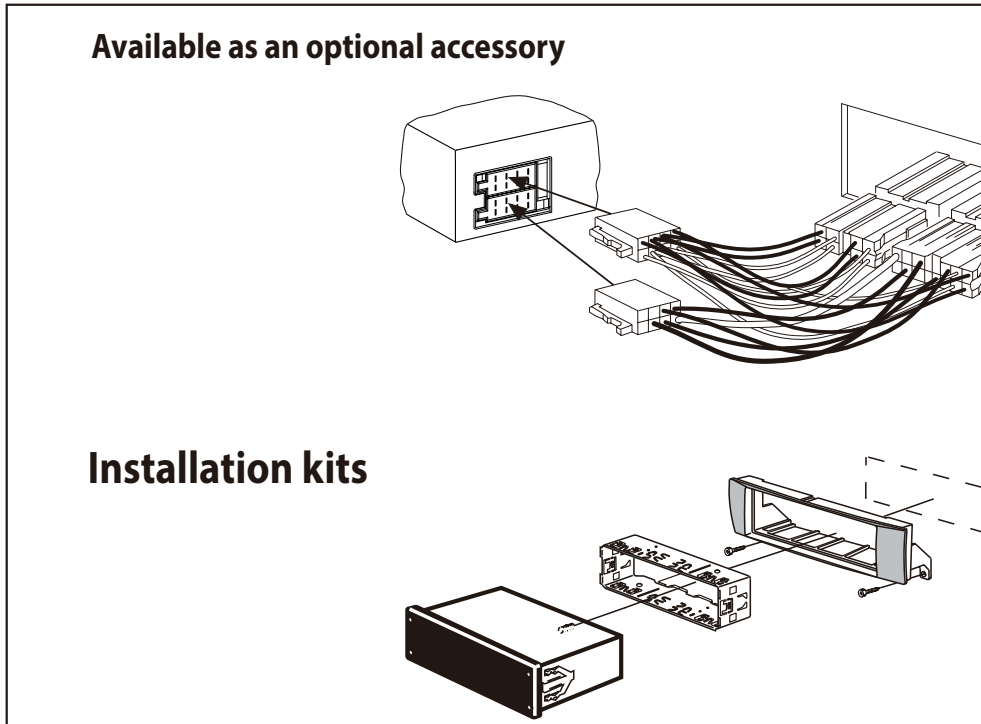
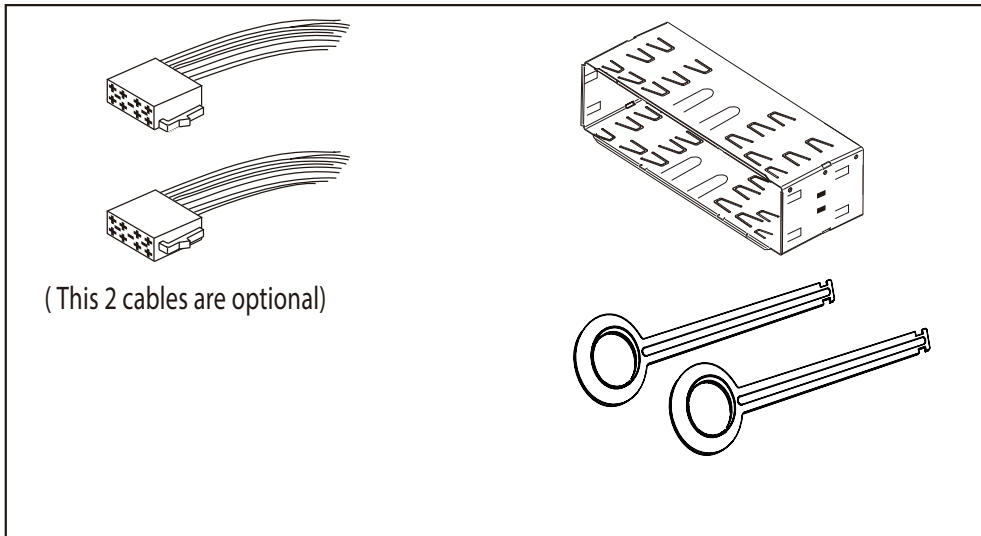

5.

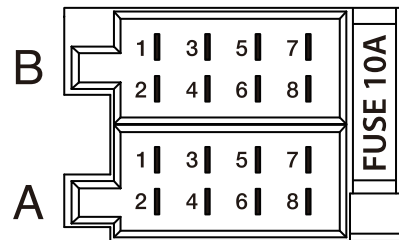
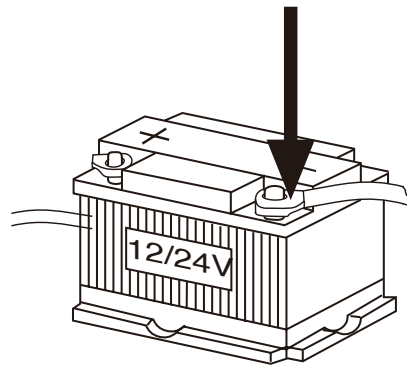

A		B	
1	NC	1	Speaker out RR+
2	Telephone Mute	2	Speaker out RR-
3	NC	3	Speaker out RF+
4	Permanent +12V	4	Speaker out RF-
5	Auto antenna*	5	Speaker out LF+
6	Illumination	6	Speaker out LF-
7	Kl.15/Ignition	7	Speaker out LR+
8	Ground	8	Speaker out LR-

*  Switched power supply +12V / max. 150 mA
 max. USB power: 5V/1A
 max. ANT. power (DAB): 12V/200mA

DAB FEATURES

DAB / DAB+	yes / yes
Band III / L-Band	yes / no
Service Scan	yes
Preset stations	15 (DAB 1,2,3)
Ensemble / Programme	yes
Comfort browsing	yes
Programme scan	yes
Service-link DAB-DAB	yes
Service-link DAB-FM	yes
Service-link DAB-DAB-FM	yes
Traffic announcement	yes (via FM RDS TA)
Radiotext	no
PTY Programme	yes
Frequency response (Hz) +/- 3 dB	20 – 20.000

ANALOG RADIO

Type of tuner	High-End Automotive Tuner Blaupunkt CODEM
World tuner (swtichable)	EU, Americas, Thailand
Wave bands	FM 1, 2, MW, LW
Radio Data System (RDS)	Alternative Frequency (AF) Clock Time (CT) Enhanced Other Networks (EON) Programme Service Name (PS) Program Types (PTY) Regional Programme (REG) Traffic Announcement (TA) Traffic Program (TP)
Travelstore	yes (FMT)
Band Scan / Preset Scan	yes / yes
Station memory	25
Sensitivity	lo / dx
Interference suppression	yes
Hi-Cut	yes
Frequency response (Hz) -3 dB	30 – 15.000

BLUETOOTH

Supported version	Bluetooth 2.1 mit EDR
Supported profiles	HFP, PBAP, A2DP, AVRCP, SPP
Pairing (number of devices)	5
Pairing Code	1234
Hands-free calling	via micro + radio speaker
Hands-free volume	variable
Microphone	built-in + external microphone
Key functions	accept / hang-up / reject call / redial
Phone book access	yes (up to 1.000 entries by phone)
Twin Connect	yes (2 simultaneously connected phones for telephony)
Navigation Audio Mix	yes (Navigation commands via A2DP)
Auto Wake-Up	yes (radio switched off / ignition on)

DATA CARRIER

USB	2x USB 2.0
Memory cards	SDHC (up to 32 GB), SD, MMC
Formatting USB / SD	FAT 32, FAT 16

MEDIA-PLAYER

Playback format	MP3, WMA
Title display	ID3-tag (version 2), file, folder
Folder- & file browsing	yes (w/o track interruption)
Multiple folder level from MSD	yes
iPod, iPhone control	yes (via USB)
Fast list browsing	yes (via second encoder)
Display modes	yes (file, folder, song, artist, album, clock, elapsed time, total time, all mode)
Display of characters	File name up to 50, tags up to 30
Variable display scrolling	yes (
Mix / Repeat / Scan	yes / yes / yes
Fast media reading	yes (from USB, SDHC, SD)
Number of supported files	> 30.000 from MSD
Bitrate (kBit/s)	32 -320
Variable bitrate	yes

EQUALIZER

Number of bands / model	3 / parametric
Bass / Treble	yes / yes (+/- 7 steps)
Balance / Fader	yes / yes (+/- 9 steps)
X-Bass	yes
Sound presets	Rock, Pop, Klassik

AMPLIFIER

Number of channels	4
Max. Power	4 x 50 Watt
Sinus power at 14.4 V	4 x 24 Watt (DIN 45324)

DISPLAY

Type / Digits	1-line / 9
Angle	Wide-view
Color	Variocolor (RGB)
Brightness	adjustable
Clock display	24 / 12 hrs

INPUTS

Antenna (number of)	2 (FM ISO + DAB SMB)
USB (number of / type)	2 (front + rear / standard A-Typ)
iPod/iPhone	yes (via front + rear USB)
Memory cards	yes
Aux-In (number of, type)	1 front (3,5 mm jack)
Telephone-mute	yes
Steering wheel control	yes (analog programmable)

OUTPUTS

Loudspeaker (number of)	4
Pre-amplifier (channel)	4 (Cinch)
Pre-amplifier (voltage)	4 Volt
Variable amplifier delay time	ja
Sub-Out	X (Cinch, var. gain/frequency)

GENERAL

Software Update	yes, via USB
Variable scan-time	yes
Confirmation-beep	yes (on/off)
Front panel	Fix-Panel
Panel / decor-ring color	black / black
Key illumination	Vario colour (RGB)
Permanent preset storage	yes (settings & presets)
Demo mode	yes
Weight (kg)	ca. 0,85
Dimension (mm)	58 x 178 x 110 (H x W x D)
Voltage supply	10.5 – 14.4 V
Current consumption	In operation: < 10A 10 sec. after switch off: < 3.5 mA
DAB-onglas antenna	yes (included in delivery)
External BT microphone	yes (included in delivery)

WARRANTY

Congratulations on your purchase of a quality Mobile Audio System! You're joining thousands of satisfied customers who enjoy & experience the benefits of the products we distribute. In the unlikely event that some technical difficulty arises with your purchase, be assured that we are most anxious to see that the problem is quickly rectified to your satisfaction. Please familiarise yourself with the following simple conditions of our warranty. This warranty covers faults through component failure or failure of the product to operate in accordance with published specifications. Product failure as a result of unreasonable environmental conditions, accident, misuse, improper installation, unauthorised repair, vehicle electrical or wiring faults or neglect etc, will not be covered by this warranty. Removal and installation costs, if any, would be paid by the owner as well as any freight or postage costs of transporting the product to Autobacs Australia PTY LTD. Autobacs Australia PTY LTD shall not be liable or responsible for any loss of use of this product or any form of consequential loss.

CONSUMER WARRANTY

This product is warranted by AudioXtra Pty Ltd to be free from defects in materials and workmanship under **NORMAL USE** for a period of **TWENTY FOUR MONTHS** from the date of purchase.

WITHIN 30 DAYS OF PURCHASE DATE:

Please return the unit for replacement to our National Service Centre or the Retailer from where you made the purchase. All accessories must be included. Proof of purchase date **must** accompany the products.

AFTER 30 DAYS OF PURCHASE DATE:

Warranty/repair and service is carried out by our National Service Centre. Repair and service will be carried out at no cost to the owner if proof of ownership and the date of purchase can be verified to the satisfaction of the authorised centre concerned with this repair. This proof should take the form of either:

- a) The warranty card accompanying this product, stamped and dated by the dealer.
- b) A Tax Invoice or Receipt showing full details of original vendor, purchaser, model number and serial number.

COMMERCIAL WARRANTY

A product used in or associated with a commercial application will carry a limited SIX MONTH warranty. An abnormal commercial application is one where usage, dust, vibration, heat/cold and other environmental conditions exist at an extreme level.

Our goods come with guarantees that cannot be excluded under the Australian Consumer Law. You are entitled to a replacement or refund for a major failure and for compensation for any other reasonably foreseeable loss or damage. You are also entitled to have the goods repaired or replaced if the goods fail to be of acceptable quality and the failure does not amount to a major failure.

Purchaser's Name: _____	
Purchaser's Address: _____ _____	
Model Number: _____	Serial Number: _____
Dealer Name: _____	Date of Purchase: / /
Dealer Address: _____	
Invoice/Sales Docket no: _____	

General Hints: To expedite service and prompt return of the equipment, please:

- a) Clearly describe the fault in detail
- b) Safely and securely pack the unit for transport
- c) Include your return address
- d) Provide proof of purchase date as outlined above

National Service Contacts:

AUTOBACS AUSTRALIA PTY LTD

Telephone: 1 300 288 029 Fax: (02) 9636 1204

email: services@audioxtra.com.au

